



# Techno-Economic Analysis of a Hybrid Campus Microgrid

Samson Dauda Yusuf <sup>a\*</sup>, Aminu Alhaji Abdulhamid <sup>b</sup>  
and Abdulmumini Zubairu Loko <sup>a</sup>

<sup>a</sup> Department of Physics, Faculty of Natural and Applied Sciences, Nasarawa State University, Keffi, Nigeria.

<sup>b</sup> Department of Electrical/Electronic Engineering Technology, School of Engineering Technology, Isa Mustapha Agwai I Polytechnic Lafia, Nasarawa State, Nigeria.

## Authors' contributions

All authors contributed to the study conception and design. Material preparation, data collection and analysis were performed by authors SDY, AAA and AZL. The first draft of the manuscript was written by author AAA, reviewed and re-drafted by author SDY and all authors commented on previous versions of the manuscript. All authors read and approved the final manuscript.

## Article Information

DOI: 10.9734/JENRR/2022/v12i3241

### Open Peer Review History:

This journal follows the Advanced Open Peer Review policy. Identity of the Reviewers, Editor(s) and additional Reviewers, peer review comments, different versions of the manuscript, comments of the editors, etc are available here: <https://www.sdiarticle5.com/review-history/91903>

Original Research Article

Received 01 August 2022  
Accepted 04 October 2022  
Published 12 October 2022

## ABSTRACT

**Aims:** To design and develop a campus micro-grid model for Nasarawa State University Keffi (NSUK), main campus, Nigeria.

**Study Design:** Econometric and financial feasibility analysis.

**Place and Duration of Study:** Department of Physics, Nasarawa State University Keffi, main campus, Nigeria, between October 2019 and September 2020.

**Methodology:** Assessment of the campus load profile, energy consumption history, grid availability and present constraints to the existing system was carried out using the Fluke Power Analyzer and Fluke Industrial Multimeter. The parameters were used as the defining inputs to HOMER Pro micro-grid design and optimization software to calculate the net present cost, levelized cost of energy, total annual cost, capital recovery factor, and the real discount rate for NSUK, main campus, Nigeria.

**Results:** For a total daily demand of 11,162.13kWh, the optimization results indicated a net present cost of \$2,499,296.31, cost of energy \$0.05, total annual electrical energy output 15,619,101.08kWh, and renewable penetration 293%, as compared to net present cost of \$9,680,196.57, cost of energy \$0.096, total annual electrical energy output 369,729.73kWh, and a

\*Corresponding author: E-mail: samsonyusufu@yahoo.com;

renewable penetration 0.0% for the existing NSUK grid-only dependent system.

**Conclusion:** Optimization results were considerably better than those obtained for the NSUK existing grid-only dependent system. Therefore, the micro-grid technology is a sustainable solution to the increasing energy demand for Nasarawa State University.

*Keywords:* Micro grid; fluke meter; HOMER Pro; net present cost; energy cost; hybrid model; techno-economic analysis.

## 1. INTRODUCTION

The evolution of new technologies in power electronics interfaces, electric vehicles and renewable energy systems is drawing attention to the need for a shift towards more active and smarter electrical power generation and distribution [1]. The immense potentials of renewable energy resources and their effective utilization in medium and long term energy policies are the core issues in the global energy sector today [2]. The traditional centralized power generation plants are inefficient; with a significant amount of energy lost as heat to the environment, in addition to producing harmful emissions and greenhouse gases. Furthermore, current power systems, especially in developing countries, suffer from several limitations such as high cost of expansion and efficiency improvement limits within existing grid infrastructure [3]. Distributed generators (DG), including renewable sources, within microgrids can help overcome power system limitations, improve efficiency, reduce emissions and manage the diversity of renewable sources [4]. Distributed energy generation is a system of electrical energy supply which employs small-scale power generation and/or storage technologies (known as distributed energy resources or DERs, which are typically in the range of 1 kW to 10,000 kW) to provide an alternative to or an enhancement of the traditional electric utility grid, and may be either connected to the local electric power grid or isolated from the grid in stand-alone applications [5,6]. They are an example of active distribution systems.

With a current daily electricity demand profile of over 11,000 kilowatt-hours (kWh), the Nasarawa State University, Keffi (NSUK) main campus is still battling with a meager monthly average load dispatch of 2,000 kilowatt-hours (kWh) from the national grid. Moreover, the National Grid supply suffers from extensive power quality problems as well as over-billing [7]. The electric power sector is characterized by some major challenges, which include sub-optimal utilization of

generation plants (partly due to insufficient gas molecule availability), inadequate transmission infrastructure and high distribution losses [8]. The generation system has an estimated installed capacity of 10,396 MW, but with availability of less than 6,000MW. Half of the generating stations are over-aged [9,10]. The transmission system is technically weak, thus very sensitive to major disturbances. The 20,000km of transmission lines are grossly inadequate for the country [11], and the entire infrastructure is essentially radial, without redundancies thus creating inherent reliability issues [10,12]. In view of the above, the main objective of the study is to determine the existing load profile of Nasarawa State University, Keffi main campus and then design a most suitable micro grid scenario for the main campus using advanced microgrid design and decision-support tools based on techno-economic energy feasibility analysis.

## 2. MATERIALS AND METHODS

### 2.1 Materials

The materials that were used in this study includes Fluke 87V Industrial Digital Multimeter, Fluke 435-II three-phase Power Quality Analyzer, Efergy Elite/ Pendoo Energy Monitor Pack, Elink Energy Management App Software, Optimization of Multiple Energy Resources (HOMER pro software), Microsoft Visio Professional ver. 2016, Parametric Technology Corporation (PTC) MathCAD Express, and MATLAB Software (Simulink/ Simscape) Version R2014a (8.3.0.532).

### 2.2 Methods

#### 2.2.1 The study area

The study was conducted at the main campus of the Nasarawa State University, Keffi (NSUK). The campus is located at latitude 08°50.0'N and longitude 07°54.5'E, with an altitude of 338m above sea level and an average total rainfall per month of 264 mm. Load assessments were

carried out on a total of 46 facilities, including 5 uncompleted building projects. Currently, the entire electricity need of the campus is supplied by the utility grid, which is Abuja Electricity Distribution Company (AEDC) through 7 distribution transformers connected in a radial distribution system network, and all located within 1 km radius of the data collection point. Additional electrical energy is obtained through decentralized and uncoordinated use of a vast number of internal combustion engines.

**2.2.2 Campus facilities loading/total installed capacity determination**

The NSUK Facilities Load/Total Installed Capacity. The assessment of the campus load profile was carried out online (grid connected) and offline (off-grid) for 46 facilities including 5 uncompleted structures. The built area for the 5 uncompleted facilities were determined; each to an approximated value. The measurements were taken using Google Earth Pro satellite camera at an eye altitude of 411 metres. Thus the installed capacity was taken as the total ampacity of all deployed fuses and Miniature Circuit Breakers at every particular loading point put together.

**2.2.3 Load categorization**

The load is categorized into the following types; Refridgeration and Air Conditioning, Heating, Illumination, and Inductive Loads. To better compute the demand contributed by each category to the overall system, the percentage of each category is aggregated. Table 1 gives the load contribution for each load category.

**2.2.4 NSUK campus load estimation**

The total NSUK load estimation was carried out following the works of Guyer [13] given as:

$$\text{Total Installed Load} = \text{kVA} \tag{1}$$

$$\text{Therefore, Load in kW} = \text{kVA} \times \text{Load Factor} \tag{2}$$

and

$$\text{Load Factor} = \text{PF} \times \text{DF} \tag{3}$$

Where PF is power factor = 0.8 (considering radial distribution system) and DF is diversity factor = 0.8 (educational institution).

Meanwhile the average daily demand forecast is determined from Table 1, using the equation suggested by Sharma and Shakya [14] given as:

$$\text{Total Average Consumption Per day (W)} = \sum \left( \frac{B \times C \times D}{7} \right) \tag{4}$$

**2.2.5 Campus consumption history profile**

For the campus power consumption history, the combined bus readings for all the substations (covering October 1<sup>st</sup>, 2019 – September 20<sup>th</sup> 2020) were captured as total annual consumption per substation in kWh.

Data was retrieved from the Pendoo gateway at an interval of 63 days using the restoration points as end dates. The receiver was paired with the CT sensor transmitter through a hotspot set up moderately secured by a token key. Data streams were retrieved in excel comma separated value (CSV) files and processed using Efergy Elink v2.1 software. The software enables data management and conversion from excel CSV format to any format. It enables retrieval of the raw data into reports using various data presentation formats including time series, d-maps, spider graphs, bar charts, histograms etc.

**2.2.6 Grid availability**

From NSUK annual load consumption history obtained from all the seven substations, the grid availability can then be determined from the relationship suggested by Abdulhamid [7] given as;

$$\text{Grid Availability} \left( \text{in } \frac{\text{Hrs}}{\text{Day}} \right) = \frac{\text{Average Daily Grid Dispatch (kWh)} \times 24 \text{hrs}}{\text{Campus Load Profile}} \tag{5}$$

**Table 1. Computation table for load categories**

Load Category	Percentage contribution	B Rating (W)	C Hours of daily use	D Days of use per week
RAC	40%	688.36	8 Hours	5
Heating	25%	430.22	4 Hours	7
Illumination	5%	86.1	16 Hours	7
Inductive Loads	30%	516.27	8 Hours	7

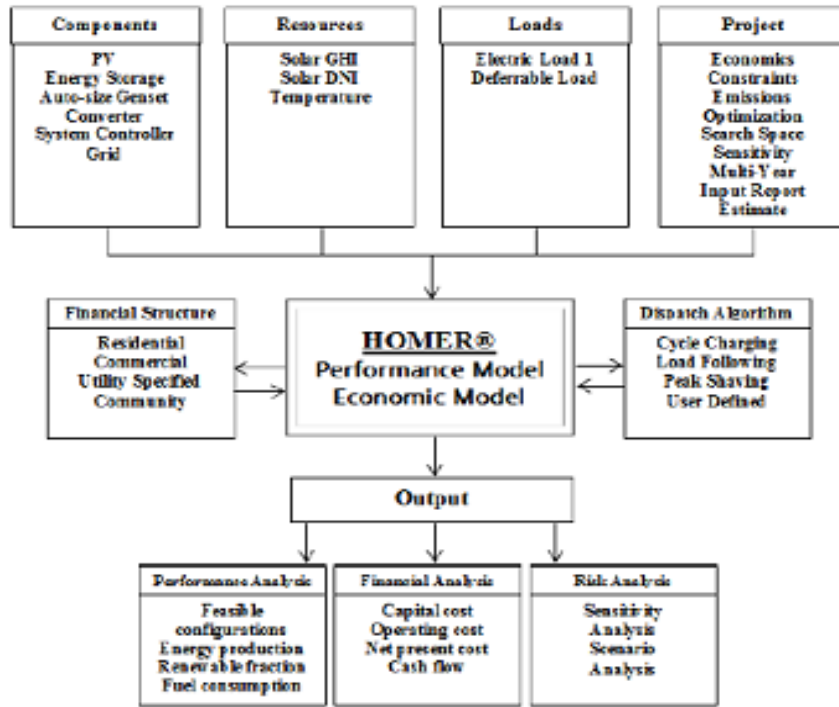

Fig. 1. Homer pro working structure

**2.2.7 Technical and economic feasibility analysis**

The feasibility analysis was carried out using the HOMER Pro Economic Metrics. In selecting the user defined inputs, the following economic assumptions were made:

- An annual discount rate of 8%;
- An annual inflation rate of 2%;
- No annual capacity shortage; and
- A project lifetime of 25 years;
- The Currency denomination used is the US Dollar owing to its stability in the global market.

The configured Homer Pro Working structure is illustrated in Fig. 1.

The targeted economic output parameters for assessment would be the system Net Present Cost (NPC), the Total Annualized Cost (TAC) and the Levelized Cost of Electricity/Energy (LCOE). Thus;

**2.2.7.1 The Net Present Cost (NPC)**

This is calculated using the expression provided in Homer Energy [15] given as:

$$C_{NPC} = C_{Cap} + C_{Rep} + C_{O\&M} + C_{Fuel} + C_{emis} + C_{Grid} - (C_{Salv} + C_{GSales}) \tag{6}$$

Where  $C_{Cap}$  is the initial capital cost,  $C_{Rep}$  is the replacement cost,  $C_{O\&M}$  is the cost of operation and maintenance,  $C_{Fuel}$  is the cost of fuel,  $C_{emis}$  is the emission penalties,  $C_{Grid}$  is the grid purchases,  $C_{Salv}$  is the salvage value, and  $C_{GSales}$  is the sales of excess energy.

**2.2.7.2 The Levelized Cost of Energy (LCOE)**

This is calculated from the expression provided in Homer Energy [15] as:

$$LCOE = \frac{C_{ann,tot} - H_{served}}{E_{served}} \tag{7}$$

Where  $C_{ann,tot}$  is the total annualized cost of the system (\$/yr),  $C_{boiler}$  is the boiler marginal cost (\$/kWh),  $H_{served}$  is the total thermal load served (kWh/yr),  $E_{served}$  and is the total electrical load served (kWh/yr).

**2.2.7.3 The Total Annualized Cost (TAC)**

This is the annualized value of the total net present cost. The total annualized cost is also given from Homer Energy [15] as:

$$C_{ann\_tot} = CRF(i \times R_{proj}) \cdot C_{NPCTot} \quad (8)$$

Where  $C_{NPCTot}$  is the total net present cost (\$),  $i$  is the annual real discount rate,  $R_{proj}$  is the project lifetime, and CRF is a function returning the capital recovery factor.

#### 2.2.7.4 The Capital Recovery Factor (CRF)

This is the ratio used to calculate the present value of an annuity (a series of annual cash flows). This is calculated from equations in Homer Energy [15] as:

$$CRF = \frac{i(1+i)^N}{(1+i)^N - 1} \quad (9)$$

Where  $i$  is the real discount rate and  $N$  is the number of years (project lifetime).

#### 2.2.7.5 The Real Discount Rate (RDR) ( $i$ )

This is a factor used to convert between one-time costs and annualized costs. The annual real discount rate (also called the real interest rate or simply interest rate) is calculated from the nominal discount rate as provided in Homer Energy [15] as:

$$i = \frac{i' - f}{1 + f} \quad (10)$$

Where  $i$  is the real discount rate,  $i'$  is the nominal discount rate (the rate at which capital can be secured), and  $f$  is the expected inflation rate.

### 3. RESULTS

#### 3.1 NSUK Campus Load Estimation

The NSUK campus load estimation was carried out using equations 1 to 3 and the result is presented as follows:

$$kW = kVA \times \text{Load Factor}$$

$$\text{Load in kW} = 2688.9(kVA) \times 0.8 \times 0.8 = 1720.9kW$$

The average daily consumption per day is obtained from Table 1, using equation 4 as:

$$\begin{aligned} \text{Average Consumption/day (W)} &= \left(\frac{688.36 \times 8 \times 5}{7}\right) + \\ &\left(\frac{430.22 \times 4 \times 7}{7}\right) + \left(\frac{86.1 \times 16 \times 7}{7}\right) + \left(\frac{516.27 \times 8 \times 7}{7}\right) \\ &= \left(\frac{27534.4}{7}\right) + \left(\frac{12046.16}{7}\right) + \left(\frac{9643.2}{7}\right) + \left(\frac{28911.12}{7}\right) \\ &= 3933.5 + 1720.87 + 1377.6 + 4130.16 = \\ &11162.13kWh \end{aligned}$$

Therefore, the total daily demand for the campus is estimated at 11,162.13kWh. The average kWh per day for each load category is presented in Table 2.

**Table 2. The average kWh per day for each load category**

	W
Load category	Average kWh per day
RAC	3933.48
Heating	1720.87
Illumination	1377.6
Inductive Loads	4130.16
<b>Total</b>	<b>11162.13</b>

#### 3.2 Campus Annual Consumption

Seven substations were monitored, namely; Admin Block, PG School, Banks' Business Area, Communication Masts substation, Convocation Square, Faculty of Arts, and Library Complex (new). The combined bus readings for all the substations (covering October 1st, 2019 – September 20th 2020) were captured as total annual consumption per substation in kWh and are presented in Table 3.

**Table 3. Annual consumption per substation**

Substation	Rating (kVA)	Loaded Annual Consumption
Admin Block	300kVA	55,459.4595kWh
PG School	300kVA	33,275.6757kWh
Banks Bus. Area	300kVA	29,578.3784kWh
Comm. Masts	300kVA	51762.1622kWh
Convoc. Square	500kVA	77,643.2433kWh
Faculty of Arts	500kVA	62,854.0541kWh
Library Complex	500kVA	59,156.7568kWh
<b>Total Combined Campus Consumption</b>		<b>369,729.73kWh</b>

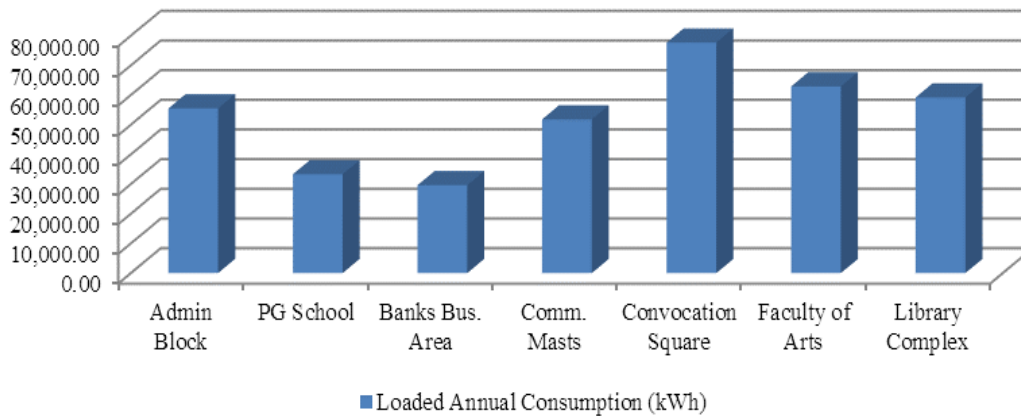

**Fig. 2. Annual energy consumption for individual substations**

**Table 4. Optimized system configuration**

System component	Rated capacity (kW)
System Converter/Controller (ABB PSTORE-PCS)	900kVA (576kW min.) – 5500kVA (3520kW max.) @ 7.17kiloAmps
Energy Storage System (with dedicated converter)	323kAh @ 90% Roundtrip Efficiency
Solar Array System (SunPower SPR-E20 327W Monocrystalline Module)	3.3483MW
Genset (Synchronization/Parallel Operation)	Auto sizeable – up to 480kW

From Table 3, the combined CT readings from all the substations indicate a total NSUK annual energy consumption of 369,729.73kWh, giving a daily average of 1013kWh. The variation of annual energy consumption for the individual substations on campus is shown in Fig. 2.

### 3.3 Grid Availability

Therefore, if the Grid Availability is less than 24hrs, then there exists insufficient grid availability. Hence from equation 5 we have:

$$\begin{aligned}
 \text{Grid Availability} \left( \text{in } \frac{\text{Hours}}{\text{Day}} \right) &= \frac{\text{Average Daily Consumption (kWh)} \times 24 \text{hrs}}{\text{Campus Load Profile (kWh)}} \\
 &= \frac{1013 \times 24}{11162.13} = 2.2 \text{ hours per day}
 \end{aligned}$$

### 3.4 Simulation Results

Simulation and optimization of the system under the assumptions above yielded the components for the best case scenario; as presented in Table 4, while Table 5 presents the general cost summary of the optimized system components. The various components' costs are automatically obtained through the links provided within the

HOMER Pro Library wizard based on user selected criteria during the sensitivity analysis carried out in the project. Tables 6 and 7 present the results of the economic and technical optimizations respectively. These parameters reflect the investment prospect of the suggested best case scenario based on the simulation and optimization. Finally, Table 8 is the table of comparison between the two systems; namely: the NSUK grid-only dependent system and the designed micro grid. These results are further illustrated in Figs. 3 to 10.

As seen from Table 8, the indices for assessment are the annual power demand, annual power output, renewable fraction, renewable penetration, net present cost; and levelized cost of energy/electricity. It is easily seen from the table that the optimized system has higher renewable fraction and higher renewable penetration than the current grid-only dependent system operated by the institution. It also has higher system output, lower cost of electricity, considerable available excess energy, which is a good leverage in net metering arbitrage and zero unmet demand. The block diagram of the proposed system design is shown in Fig. 11.

**Table 5. General cost summary for the system architecture**

System component	Initial capital (\$)	Replacement period (Years)	Replacement cost (\$)	Operation & maintenance cost	Salvage value (\$)	Fuel cost (400kW @ ¼ Load for ½ hrs/ Day/Week)
System Converter /Controller (ABB PSTORE-PCS)	\$351,718.75	15	\$351,718.75	\$9,566.75	\$140,687.50	-
Energy Storage System (Modularized Lead Acid BESS with dedicated converter)	\$359,029.65	15	\$359,029.65	\$9,765.61	\$143,611.86	-
Solar Array System (SunPower SPR-E20 327W Monocrystalline Module)	\$1,379,514.83			\$23,451.75	\$0.00	-
Genset (MANTRAC Auto sizeable – up to 480kW)	\$240,000.00	15	\$240,000.00	\$6,528.00	\$96,000.00	\$21,325.12
<b>Overall System</b>	<b>\$2,330,263.23</b>		<b>\$950,748.40</b>	<b>\$49,312.11</b>	<b>\$380,299.36</b>	<b>\$21,325.00</b>
<b>Total project capital cost</b>					<b>\$2,971,349.50</b>	

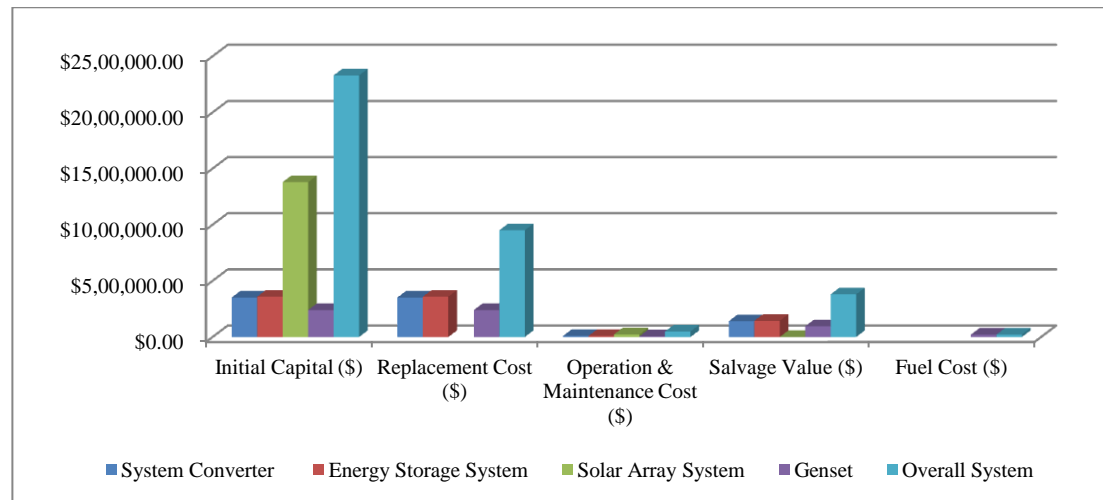

**Fig. 3. General cost profile**

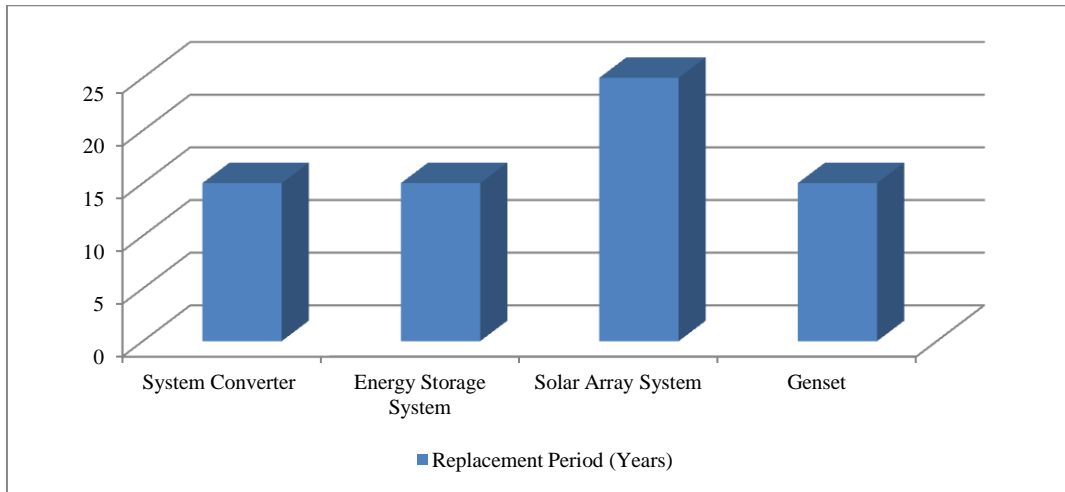

Fig. 4. Replacement period

Table 6. Optimization results for the economic model

Economic parameters	Value/units
Capital Cost (\$)	\$2,971,349.50
Operation & Maintenance Cost (\$)	\$49,312.11
Replacement Cost (\$)	\$950,748.40
Salvage Value (\$)	\$380,299.36
Fuel Cost (\$)	\$21,320.00
Annualized Total Cost (\$/yr)	\$292,417.67
Capital Recovery Factor	0.0782
Nominal Discount Rate (%)	0.08
Real Annual Discount Rate (%)	0.06
Inflation Rate (%)	0.02
Discount Factor	See Discounted Cash Flow Table
Net Present Cost (NPC) (\$)	\$2,499,296.31
Levelized Cost of Energy (COE) (\$/kWh)	\$0.05

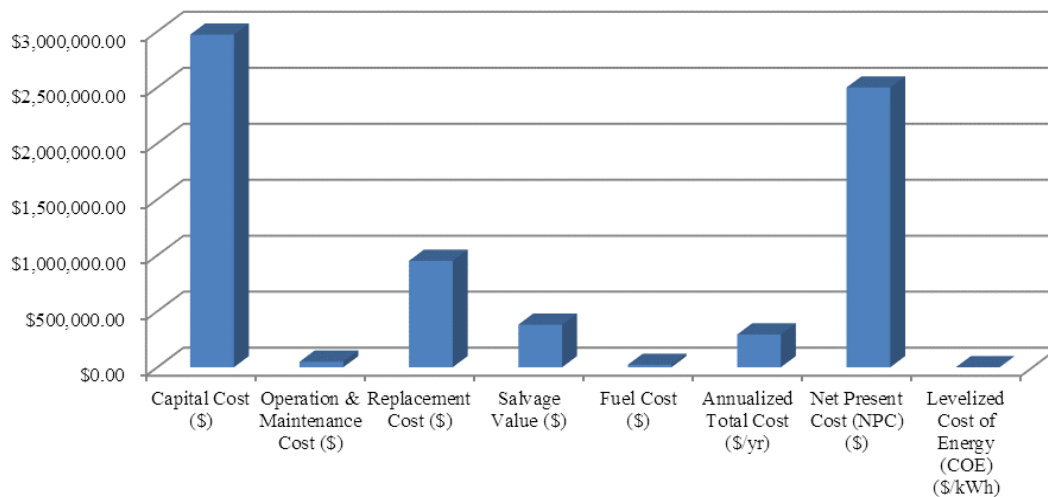
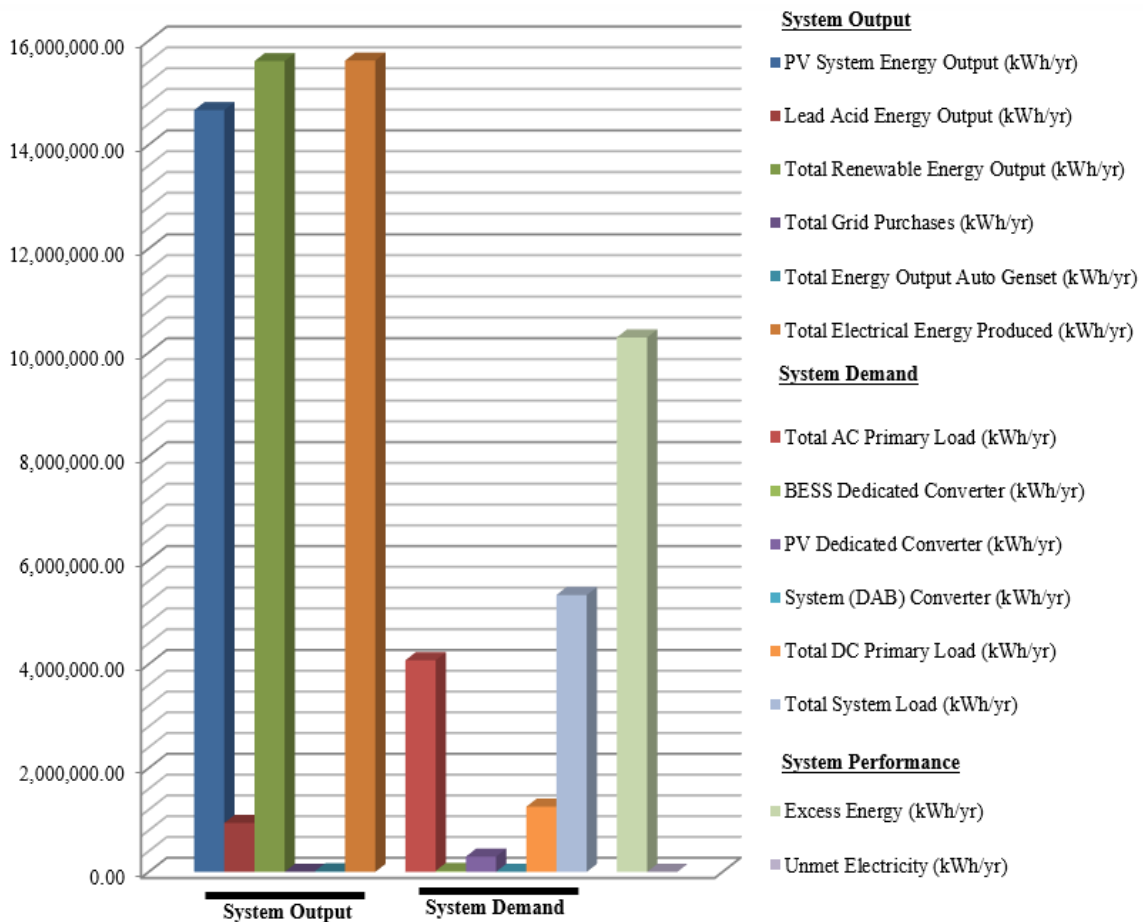

Fig. 5. Economic parameters

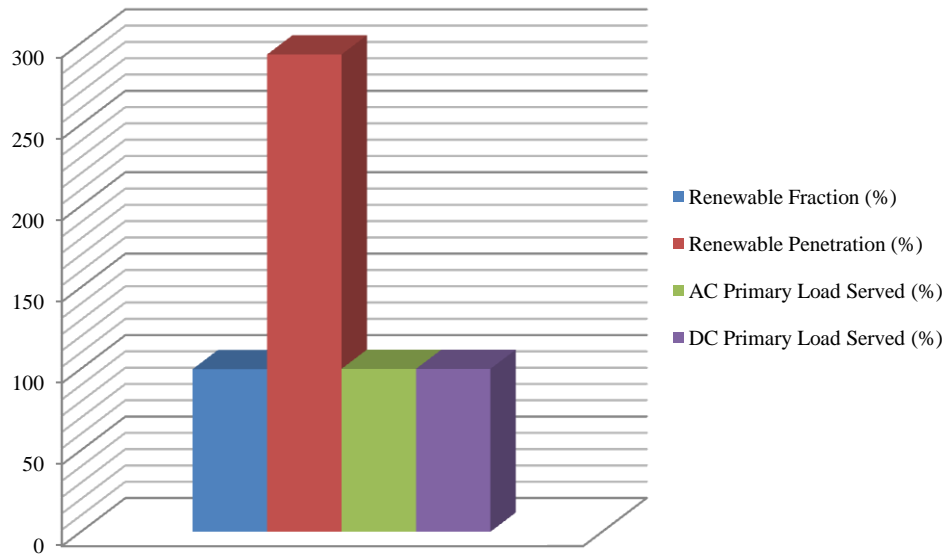

**Table 7. Optimization results for the performance model**

<b>Technical (Performance) parameters</b>	<b>Value/units</b>
<b>System output</b>	
PV System Energy Output (kWh/yr)	14,665,545.24
Lead Acid BESS Energy Output (kWh/yr)	943,160
Total Renewable Energy Output (kWh/yr)	15,608,705
Total Grid Purchases (kWh/yr)	0.00
Total Energy Output from Auto-sizeable Genset (kWh/yr)	10,395.84
Total Electrical Energy Produced (kWh/yr)	15,619,101.08
<b>System demand</b>	
Total AC Primary Load (kWh/yr)	4,074,177.45
BESS Dedicated Converter (kWh/yr)	18,863.20
PV Dedicated Converter (kWh/yr)	293,310.91
System (DAB) Converter/Controller (kWh/yr)	0.00
Total DC Primary Load (kWh/yr)	1,255,334.11
Total System Load (kWh/yr)	5,329,512
<b>System performance</b>	
Excess Energy (kWh/yr)	10,289,589.52
Unmet Electricity (kWh/yr)	0
Renewable Fraction (%)	99.80
Renewable Penetration (%)	293
AC Primary Load Served (%)	100%
DC Primary Load Served (%)	100%



**Fig. 6. System output and demand**



**Fig. 7. System performance**

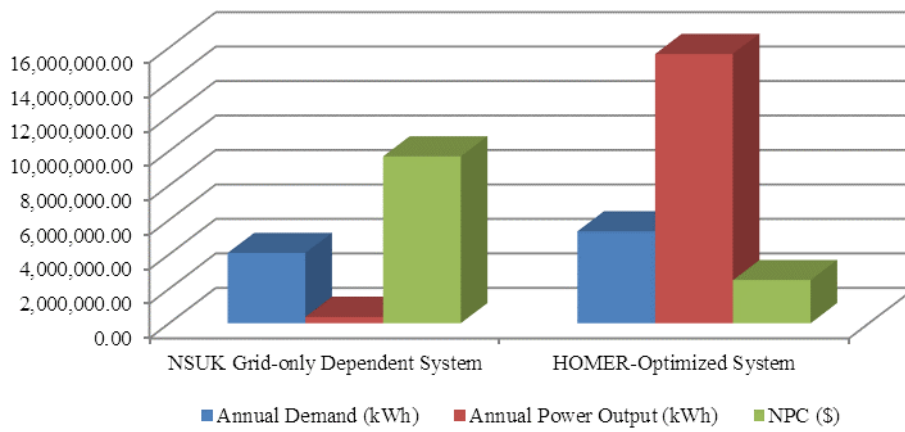

**Fig. 8. Techno-economic performance**

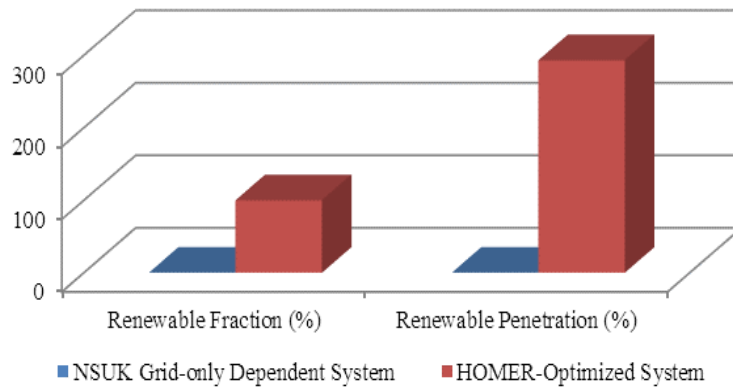
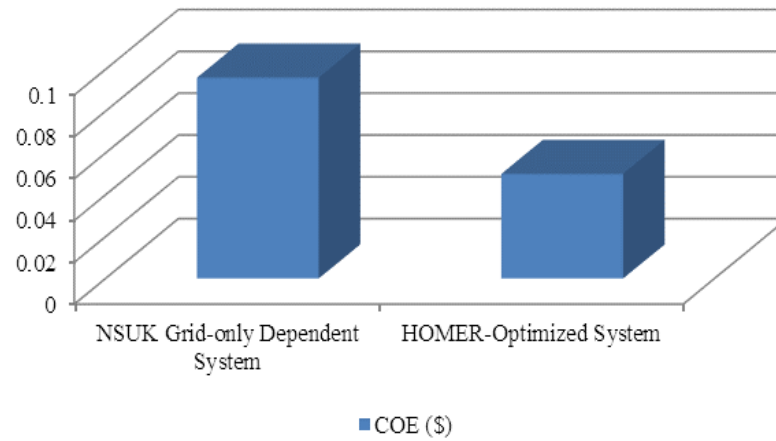

**Fig. 9. Renewable profile**

**Table 8. Comparison of the 2 systems**

	Annual demand (kWh)	Annual power output (kWh)	Renewable fraction (%)	Renewable penetration (%)	COE (\$)	NPC (\$)
NSUK Grid-only Dependent System	4,074,177.45	369,729.73	0	0	0.096	9,680,196.57*
HOMER-Optimized System	5,329,512	15,619,101.08	99.80	293	0.05	2,499,296.31

*\*Assuming zero grid interruptions*



**Fig. 10. Levelized cost of energy**

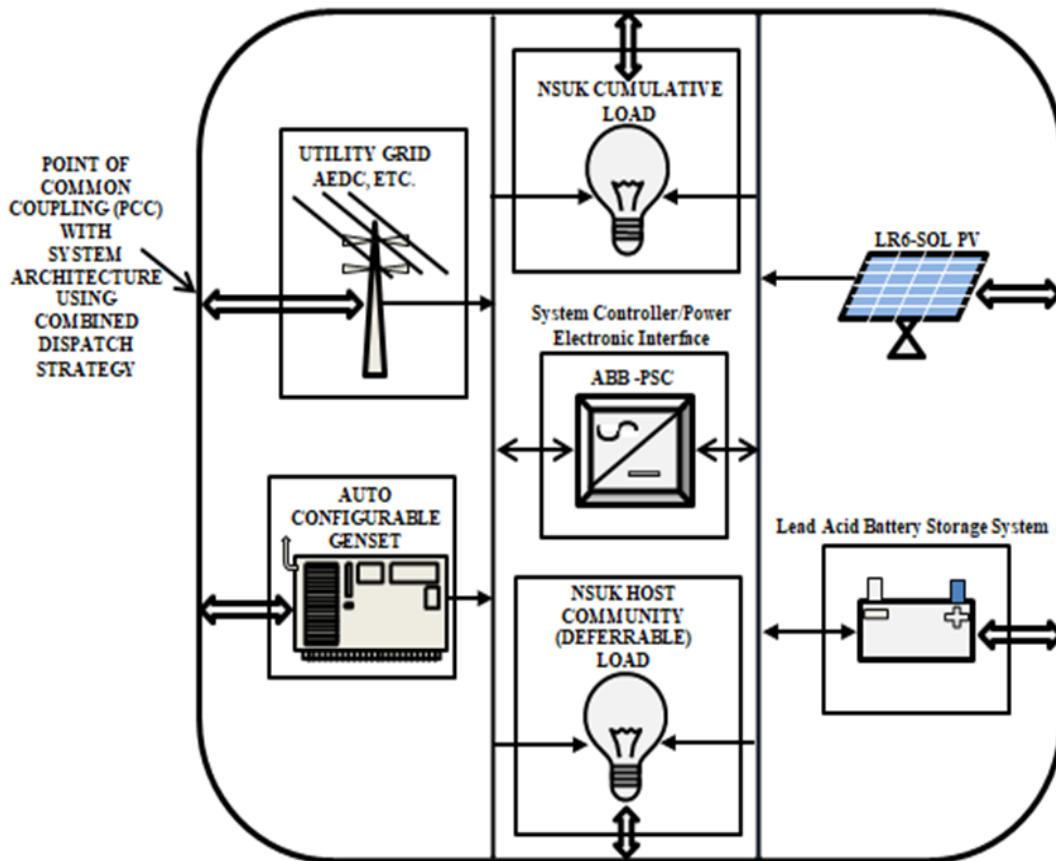

Fig. 11. Block diagram of the proposed micro grid system

#### 4. DISCUSSION

The system economic and performance indices that enables comparison of the two systems; namely: the current NSUK grid-only-dependent system and the estimated optimized system using the HOMER Pro has been presented. However, total annual power demand, total annual power output, renewable energy penetration, renewable energy fraction, net present cost and levelized cost of electricity/energy all have significant influence on the assessment and/or choice of energy options during decisions in energy project investments. The International Energy Agency (IEA) multi-tier framework (MTF) standard for energy access sets minimum acceptable energy access at 68% of deployed demand at a minimum period of 8 hours daily [16]. Findings from this study have shown that the total annual power demand for NSUK grid-dependent system, which resulted from the determination of the existing campus load profile reflecting the total installed load/capacity of the campus, and thus the

demand deployed to the grid dispatch; was obtained as 4,074,177.45kWh/yr, while the optimized estimated total annual power demand was 5,329,512kWh/yr. The increased demand in the latter is due to the addition of renewable energy components to the existing system during optimization. This finding differs from that of Nazir et al. [17], who used the HOMER Pro for the optimization of renewable energy sources for a micro grid model design at Padang, Indonesia; and obtained 617,945kWh/yr. This is because their load assessment measured an average consumption of 1 hour per day at 4 days a week, using a power analyzer; while this study measured 24 hours of consumption per day at 7 days a week, using energy monitoring equipment with remote access capabilities.

According to the global standard set by the International Energy Agency (IEA), modern energy access for an average rural household of 6 persons is 50 kWh per capita per annum and 100 kWh per capita per annum in urban areas [16]. Findings from this study have revealed that

the total annual power output of the NSUK grid-only dependent system was estimated at 369,729.73kWh/yr. This suggests over 90% of unmet electricity demand or less than 10% grid dispatch availability for 2.2 hours daily (which is even more damaging for the utility's business interest). On the other hand, the estimated optimized total annual power output was 15,619,101.08kWh/yr, which translates to 0% of unmet electricity demand or 293% dispatch availability for 23.5 hours daily. This finding differs from that of Lu et al. [18], who worked on the design and application of micro grid operation control system based on IEC 61850 at Nanjing, China; and obtained 175,200kWh/yr using a 3-layered adaptive control strategy. This difference is as a result of the difference in the method of optimization, as well as the selected scaled annual average, which for this study is 99.1%, while in their case was 85%. Another reason for the dissimilarity in results is the exclusion of a system controller in their work; which is usually responsible for the dispatch control.

The Renewable Portfolio Standard (RPS); a global regulation adopted by US, UK, Italy, Poland, Sweden, Belgium, etc. requires that private electricity retail sellers and publicly owned electric utilities should procure 20-50% of their electricity from eligible renewable energy resources by 2030 [19]. The findings of this study revealed a renewable penetration of 293%, which differs from the 72% renewable penetration obtained by Restrepo et al. [20], who implemented the design and performance analysis of a micro grid also using HOMER Pro at Medellin, Colombia. This dissimilarity is largely due to topographic variations in the two micro grid locations (Keffi in Nigeria, and Medellin in Colombia).

The renewable fraction is an important index used by financial donors globally to assess the green energy capability of electricity producers. It is also a ticket for financial incentives such as the California State Green Tax Waiver and the Chinese Credit Line [21]. Further findings from this study suggest a 99.8% renewable fraction, which differs from that of Okundamiya and Omorogiuwa [22], who also using HOMER Pro on the analysis of an isolated micro grid; at Ekpoma, Nigeria and obtained a 100% renewable fraction, because they simulated a much smaller system with an annual output of 276,800kWh/yr, and an annual demand of 276,799.615kWh/yr.

The Net Present Cost (NPC) is the most important of all economic parameters adopted in this study as it provides the complete picture of the total cost value of the investment at the end of its 25 year lifetime. This helps with the cost-angle of the investment decisions. The Net Present Cost of \$2,499,296.31, obtained from this study differs from that of Sahoo et al. [23] who obtained a net present cost of INR155,764,282.86 (equivalent to \$2,180,699.96) using HOMER Pro on the feasibility study of micro grid installation in an educational institution with grid uncertainty at Chennai India; and this is largely due to the inclusion of a wind-based DER and the exclusion of a system controller (which also resulted in the absence of a dispatch algorithm).

Levelized Cost of Energy (LCOE) is one of the two most important economic parameters used in this study for assessing the feasibility of the estimated system; and the IEA sets cost of electricity at 20% or less of average household income for 365kWh/yr [16]. The LCOE is also an index for assessing the viability and ranking of any electricity/energy project investment which reflects the cost of a unit of electricity incurred by the system. It is revealed from the findings of this study that; while the NSUK grid-only dependent system accesses electricity at \$0.096/kWh, the estimated optimized system delivers energy at \$0.05/kWh. Thus; given the excess energy of over 10,280,000kWh/yr for the optimized system, this translates into unlimited access to 24 hours of electricity; 7 days a week absolutely free of charge in addition to an unrivalled advantage in energy arbitrage. The findings of Iqbal and Siddiqui [24], who worked on optimal configuration analysis for a campus micro grid, using HOMER Pro; at western Uttar Pradesh, India revealed a levelized cost of energy as \$0.2422/kWh, which differs from the findings of this study. This is largely because they ignored the effect of battery-wear cost in their optimization over an assumed float-life of 10 years. Another reason for the dissimilarity is the inclusion of a wind-based DER in their optimization.

Therefore, all the reviewed literature differed in their findings from the current study. A major factor responsible for the dissimilarities is the fact that, while most of the previous studies employed the use of the synthetic load configuration available in HOMER Pro, the current study carried out an actual assessment of the Campus load profile, and even went further to determine

an aggregation of load contribution by the various components of the Campus total installed load. HOMER Pro provides only a synthetic load approximation which does not always account for all practical non-idealities. Other factors responsible for the differences include different parametric targets, the exclusion and inclusion of different types of DERs; as well as variations in local climatic conditions, since most of the DERs are climate-dependent.

## 5. CONCLUSION

This research carried out technical and economic feasibility study of an energy investment project through the design and development of a campus hybrid microgrid model for Nasarawa State University, Keffi (NSUK) main campus, which suffers from grid uncertainty. The approach involved a 4-tier methodology structured into; campus load estimation, supply-side grid parameter estimation, synthesis of locally available (natural) renewable energy resources through optimization of DERs using the highly sophisticated optimisation software (HOMER Pro); and validation of the HOMER-optimized parameters. Measured grid conditions and the campus load profile were used as input parameters for the software. The US dollar was used as the currency denomination owing to its global market strength to ensure consistency in the assumed inflation rate. The simulation results indicate a highly feasible system characterized by maximum fidelity among various system components, and with considerable cost and energy savings in the optimized microgrid design. Annual energy output, renewable penetration, cost of energy and net present cost of the system were the target outputs that were used to compare the existing system and the HOMER-optimized system, and they all proved superiority of the HOMER-optimized system over the NSUK grid-only dependent system. However, future work is recommended in areas of design and analysis of wireless system technologies suitable for the design of micro grid systems. This is because wireless technologies form an integral part of the smart feature, which heavily characterizes micro grid systems control. Also, Environmental impact assessment would be a valuable resource for the complete adoption of this work for full implementation. It is also recommended that the campus emission levels be studied in order to find ways of reducing the carbon footprint. It is highly likely that in the near future, penalties are likely to be in place for greenhouse emissions.

## CONSENT

As per international standard or university standard, respondents' written consent has been collected and preserved by the author(s).

## ETHICAL APPROVAL

It is not applicable.

## COMPETING INTERESTS

Authors have declared that no competing interests exist.

## REFERENCES

1. Çetinbaş İ, Tamyürek B, Demirtaş M. Design, analysis and optimization of a hybrid micro grid system using HOMER software: Eskişehir Osmangazi University example. *Int. Journal of Renewable Energy Development (IJRED)*. 2018;8(1):65-79.
2. Mengelkamp E, Gärttner J, Rock K, Kessler S, Orsini L, Weinhardt C. Designing micro grid energy markets: A case study: The Brooklyn Microgrid. *Applied Energy*. 2018;2(10):870-880. DOI:<https://doi.org/10.1016/j.apenergy.2017.06.054>
3. Jamil M, Hussain B, Abu-Sara M, Boltryk RJ, Sharkh SM. Micro grid power electronic converters: state of the art and future challenges. *Proceedings of the 44th International Universities Power Engineering Conference (UPEC)*, Glasgow, UK; 2009. Available:<https://ieeexplore.ieee.org/document/5429441>
4. Abu-Sharkh S, Arnold RJ, Kohler J, Li R, Markvart T, Ross JN, et al. Can micro grids make a major contribution to UK energy supply? *Renewable and Sustainable Energy Reviews*. 2006;10(1):78-127.
5. Hadjidemetriou L, Zacharia L, Kyriakides E, Azzopardi B, Azzopardi S, Mikalauskiene R, et al. Design factors for developing a university campus microgrid. *Proceedings of IEEE International Energy Conference (ENERGYCON)*, Limassol, Cyprus; 2018. DOI:10.1109/ENERGYCON.2018.8398791
6. Li F, Zhou F, Li R. *Microgrid technology and engineering application*. San Diego, California: Academic Press; 2015.
7. Abdulhamid AA. An optimized campus hybrid micro grid model based on technical

- and economic feasibility analysis. *Journal of Engineering, Science and Technology (LAJAST)*. 2020;4(3):1-16.  
Available: [www.asuplafia.org.ng/journal](http://www.asuplafia.org.ng/journal)
8. Advisory Power Team (APT). Nigeria Power Baseline Report. A Publication of the Advisory Power Team, Office of the Vice President in Conjunction with Power Africa. 3–6. 2015.  
Accessed 3 March 2019.  
Available:  
<http://www.mypower.ng/downloads/baseline-report>.
  9. Power Africa. 2018 Annual Report; 2018.  
Accessed 3 March 2019.  
Available: [https://www.usaid.gov/files/documents/2018-Annual\\_Report1015\\_508](https://www.usaid.gov/files/documents/2018-Annual_Report1015_508)
  10. Sambo AS, Garba B, Zarma IH, Gaji MM. Electricity generation and the present challenges in the Nigerian power sector. *Journal of Energy Power Engineering*. 2010;6(1):9-14.  
Available: <https://www.researchgate.net/publication/228399732-Electricity-Generation>
  11. Boddapati V, Daniel SA. Optimal design and techno-economic analysis of a Microgrid for community load applications. In *Advances in Clean Energy Technologies 2021* (pp. 361-374). Springer, Singapore.
  12. Nigerian Electricity Regulatory Commission (NERC). Nigerian Electricity Supply Industry (NESI); 2018.  
Accessed 14 April 2019.  
Available:  
<https://www.nerc.gov.ng/index.php/home/nesi>.
  13. Guyer JP. Introduction to electrical power requirements for buildings. Course Material for Continuing Education and Development, Inc. 9 Greyridge Farm Court Stony Point, NY 10980. 2010.  
Accessed 2 October 2021.  
Available: <https://www.cedengineering.com>
  14. Sharma DK, Shakya SR. Training manual for engineers on solar PV system. Technical Report developed for Energy Sector Assistance Programme, Alternative Energy Promotion Centre (AEPIC), Khumaltar Height, Lalitpur, Kathmandu, Nepal. 2011;151-155.  
DOI: 10.13140/2.1.3156.9607
  15. Homer Energy. HOMER energy launches HOMER pro - next generation microgrid optimization software; 2014.  
Accessed 22 August 2019.  
Available: <https://www.homerenergy.com/products/pro/index>
  16. Moss T, Bazilian M, Blimpo M, Culver L, Kincer J, Mahadavan M, et al. The modern energy minimum: the case for a new global electricity consumption threshold; 2021.  
Accessed 22 February 2022.  
Available: <https://www.energyforgrowth.org/report/modern-energy-minimum/>
  17. Nazir R, Laksono HD, Walidi EP, Ekaputra E, Coveria P. Renewable energy sources optimization: a micro-grid model design. *Proceedings of the International Conference on Alternative Energy in Developing Countries and Emerging Economies*, 2013. Bangkok, Thailand. 2014;52(1):316-327.  
DOI: 10.1016/j.egypro.2014.07.083
  18. Lu W, Zhao Y, Li W, Du H. Design and application of micro grid operation control system based on IEC 61850. *Journal of Modular Power Systems and Clean Energy*. 2014;2(3):256-263.  
DOI 10.1007/s40565-014-0074-y.
  19. Heeter J, Speer B, Glick MB. International best practices for implementing and designing renewable portfolio standard (RPS) policies. Technical Report NREL/TP-6A20-72798. 2019;9-13.  
Available: [www.nrel.gov/publications](http://www.nrel.gov/publications)
  20. Restrepo D, Restrepo-Cuestas B, Trejos A. Micro grid analysis using HOMER: a case study. *DYNA*. 2018;85(207):129-134.  
DOI: <http://doi.org/10.15446/dyna.v85n207.69375>.
  21. National Conference of State Legislators. State renewable portfolio standards and goals; 2021.  
Accessed 20 September 2021.  
Available: <https://www.ncsl.org/research/energy/renewable-portfolio-standards>.
  22. Okundamiya MS, Omorogiuwa O. Analysis of an isolated micro grid for Nigerian terrain. 59th IEEE International Midwest Symposium on Circuits and Systems (MWSCAS), 16-19 October 2016. Abu Dhabi, UAE; 2016.  
DOI: 10.1109/MWSCAS.2016.7870060
  23. Sahoo AK, Abhitharan KP, Kalaivani A, Karthik TJ. Feasibility study of micro grid installation in an educational institution with grid uncertainty. In *Proceedings of the 4th International Conference on Eco-friendly Computing and Communications Systems (ICECCS 2015)*, Kurukshetra, India. 2015; 70(1):550-557.

- DOI: 10.1016/j.procs.2015.10.099
24. Iqbal I, Siddiqui AS. Optimal configuration analysis for a campus micro grid – a case study. Protection and Control of Modern Power Systems. 2017;2(23):1-12. DOI 10.1186/s41601-017-0055-z

© 2022 Yusuf et al.; This is an Open Access article distributed under the terms of the Creative Commons Attribution License (<http://creativecommons.org/licenses/by/4.0>), which permits unrestricted use, distribution, and reproduction in any medium, provided the original work is properly cited.

*Peer-review history:*  
*The peer review history for this paper can be accessed here:*  
<https://www.sdiarticle5.com/review-history/91903>